

# ONTARIO



**STOSA**  
CUCINE

# ontario

CONTEMPORARY  
CONTEMPORARY  
FLAVOUR  
FLAVOUR

Ontario, il punto di vista assolutamente personale ed originale con cui Stosa interpreta la cucina contemporanea. Una chiave di lettura di uno stile da vedere con occhi diversi per scoprirne le tante anime e variazioni, adattando una tradizione, che ha radici nella storia, alla sensibilità contemporanea.

Ontario, the absolutely personal and original point of view with which Stosa interprets the contemporary kitchen. A key to reading a style to be seen with different eyes, in order to discover its numerous souls and variations, adapting a tradition rooted in history to contemporary sensitivity.





# Contrasti Armonici

La versione contemporanea della cucina italiana, luogo curato nei dettagli per tradizione culturale, dove si esprime stile e personalità. Con un duplice obiettivo estetico e funzionale.

Un gioco di forme, finiture e accostamenti che raccontano cucine classiche con inedite declinazioni contemporanee.

#### HARMONIOUS CONTRASTS

The contemporary version of the Italian kitchen, a place where meticulous attention is paid to details by cultural tradition, where style and personality are expressed. With a dual, aesthetic and functional, aim. A game of shapes, finishes and combinations which reveal the stories of classic kitchens with unprecedented contemporary declinations.





# SEGNO D' AUTORE



Una composizione che esplora le tendenze più accattivanti in materia di design, scegliendo come elemento caratterizzante l'ampio bancone di lavoro a isola dalle linee sobrie e geometriche.

#### THE DESIGNER TOUCH

A composition which explores the most attractive design trends, choosing the large island work counter, with its plain, geometric lines, as the characterising feature.











Il bancone snack apre il lato più moderno di Ontario. Il disegno minimal si mixa con l'atmosfera informale della cucina. A lato la cappa in acciaio per un'alternativa hi-tech.

The snack bar opens up the more modern side of Ontario. The minimal design merges with the informal atmosphere of the kitchen. The steel hood shown at the side offers a hi-tech alternative.











# TIMELESS DESIGN



Crea un ambiente caldo e rassicurante la ricca anta in legno massello sottolineata dalla finitura in rovere gessato, con maniglie perfettamente integrate che mettono in risalto l'essenzialità dello stile contemporaneo.

**TIMELESS DESIGN**  
A warm and reassuring environment is created by the rich solid wood door, highlighted by the striped oak finish, with perfectly integrated handles which emphasise the essential lines of the contemporary style.









Un tocco di modernità anima la cucina dalle forme tradizionali. La cappa si arricchisce di funzionali elementi in legno mentre le ante all'inglese si armonizzano con il tavolo laminato, disponibile in tutte le finiture ONTARIO.

#### ESSENTIAL CHIC

A touch of modernity brightens up the traditionally styled kitchen. The hood is enriched with functional elements made of wood, while the English doors harmonise with the laminate table, available in all the ONTARIO finishes.



# ESSENTIAL CHIC









# ESTRO E FUNZIONALITÀ



Dal binomio fra emozionalità e concretezza prende forma questa composizione ariosa che gioca sui volumi e sugli spazi, per una cucina con una forte personalità, dai raffinati tratti stilistici.

**CREATIVITY AND FUNCTIONALITY**  
The binomial between emotionality and tangibility conveys shape to this light composition that plays on volumes and spaces, for a kitchen with a strong personality and refined stylistic features.







# Easy living

Elementi tradizionali si affiancano a finiture in frassino laccato e a piani laminati in pietra serena. Una soluzione che sorprende ancora con il moderno piano di lavoro basso e proiettato in avanti, a creare un ideale collegamento con la zona living.

Traditional elements flank lacquered ash finishes and Serena stone laminate tops. A solution that continues to surprise with the modern lowered work counter which is projected forwards, creating an ideal link with the living area.









# SORPRENDERSI OGNI GIORNO



L'eleganza senza tempo di una cucina che sottolinea lo stile tradizionale italiano si arricchisce di elementi contemporanei, per un risultato esteticamente impeccabile. In alternativa alla penisola le basi ribassate con cambio profondità. I cassetti e i cestoni sono dotati del sistema di chiusura ammortizzato.

#### **SURPRISE YOURSELF EVERY DAY**

The timeless elegance of a kitchen that highlights traditional Italian style is enriched by contemporary elements, for an aesthetically impeccable result. An alternative to the peninsula is offered by the lowered base units with changed depth. The drawers and baskets are equipped with the slow motion system.









# UN CARATTERE CHE LASCIA IL SEGNO



E' il top in finitura pietra che prosegue fino a formare una funzionale penisola per la zona pranzo l'elemento caratterizzante di questa composizione, che interpreta gli orientamenti stilistici più attuali senza rinunciare alla naturalità.

#### **A FEATURE THAT LEAVES ITS MARK**

The marble top that forms a functional peninsula for the dining area is the characterising element of this composition, which interprets the latest stylistic orientations without sacrificing naturalness.









Esalta le caratteristiche estetiche e funzionali del legno la squisita finitura in frassino laccato color magnolia. Note che accordano equilibrio ed eleganza donando un'espressione di naturalezza a tutta la zona living.

**REFINED FUNCTIONALITY**

The aesthetic and functional features of wood are enhanced by the exquisite finish in magnolia-coloured lacquered ash. These notes unite balance and elegance, conveying a natural expression to the whole living area.



RAFFINATA  
FUNZIONALITÀ









# LASCIARSI AFFASCINARE



Una composizione in cui convivono le manifestazioni più interessanti dello stile tradizionale italiano, dove la componibilità si esprime con un linguaggio assolutamente contemporaneo.

#### LET YOURSELF BE CHARMED

A composition in which the most interesting manifestations of traditional Italian style cohabit, where modularity is expressed with an absolutely contemporary language.





Composizione / Composition 01



- Maniglia M81E
- Top laminato unicolor Moka sp. 4cm.
- Bancone di lavoro isola
- Sgabello Venere
- Handle M81E
- Moka laminate unicolor top 4cm. thick
- Work counter
- Venere stool

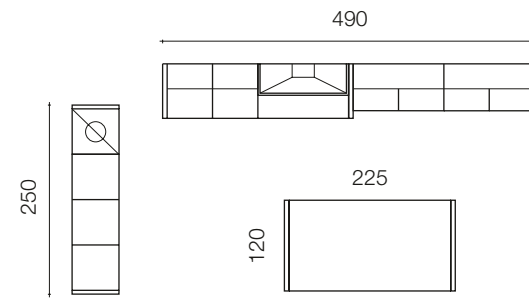

Page: 06-07

Composizione / Composition 02



- Maniglia M81
- Top muratura Sasso Botticino profilo becco civetta sp. 6cm.
- Bancone di lavoro isola
- Handle M81
- Botticino stone masonry tops with bullnose edge 6cm. thick
- Work counter

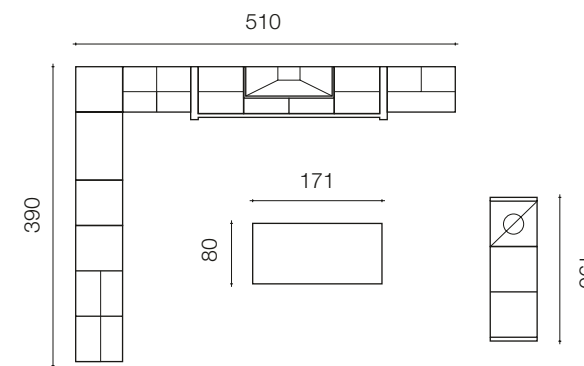

Page: 10-11

Composizione / Composition 03



- Maniglia M81E
- Top laminato perlino velvet sp. 6cm.
- Tavolo Romagnolo 140x80
- Sedie legno impagliate
- Handle M81E
- Velvet frost laminate top 6cm. thick
- Romagnolo Table 140x80
- Chair with straw seat

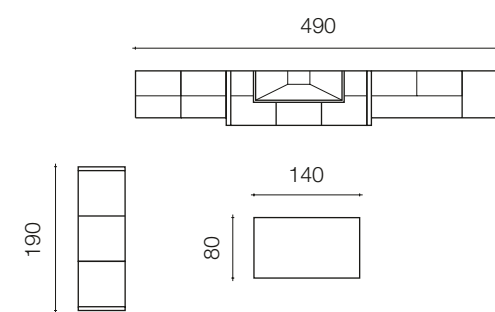

Page: 14-15

Composizione / Composition 04



- Maniglia M81B
- Top laminato unicolor Moka sp.4
- Bancone di lavoro isola
- Handle M81B
- Moka laminate unicolor top 4cm. thick
- Work counter

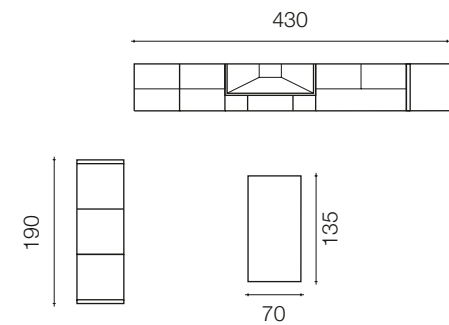

Page: 18-19

Composizione / Composition 05



- Maniglia 81E
- Top grabla velvet sp.4cm.
- Sedie legno impagliate
- Tavolo rotondo Luna
- Handle M81E
- Grabla velvet top 4cm. thick
- Chair with straw seat
- Luna round table

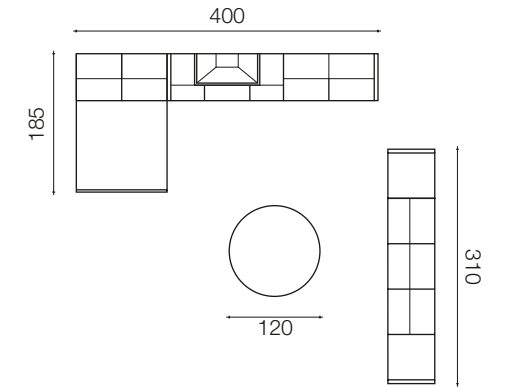

Page: 24-25

Composizione / Composition 06



- Maniglia M81E
- Top laminato Pietra Vecchia sp. 4cm
- Sgabello Venere
- Handle M81E
- Pietra Vecchia laminate top 4cm. thick
- Venere stool

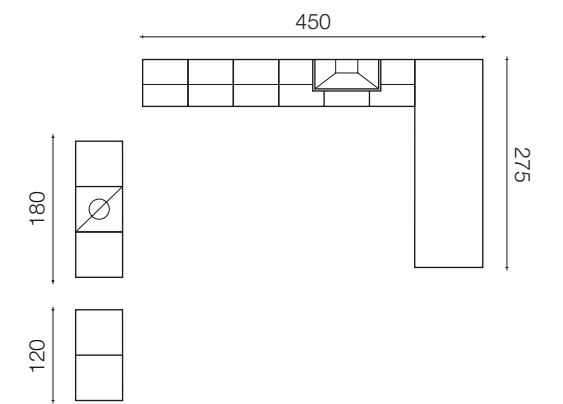

Page: 32-33

Composizione / Composition 07



- Maniglia M81D
- Top laminato pietra di Nanto sp. 4cm.
- Handle M81D
- Nanto stone laminate top 4cm. thick

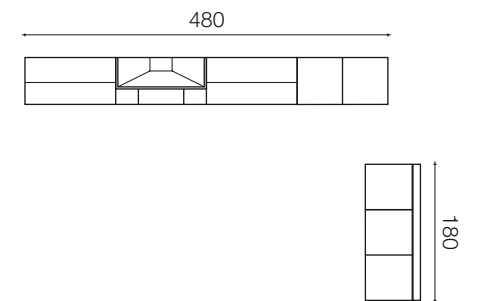

Page: 36-37





**ROMAGNOLO** L 140 P 80 H 78.5 cm



Tavolo allungabile piano impiallacciato con 2 prolunghe laterali. Disponibile in tutte le finiture Ontario

Extensible table with veneered top with 2 lateral extensions. Available in all Ontario finishes.

**FISSO** L 100/125/150 P 80 H 78.5 cm



Tavolo piano laminato. Disponibile in tutte le finiture Ontario

Fixed table, with laminate top. Available in all Ontario finishes.

**LUNA** Ø 120 H 78,5 cm



Tavolo rotondo con piano impiallacciato. Disponibile in tutte le finiture Ontario

Round table with veneered top. Available in all Ontario finishes.

**PANCA** H 85 cm



Elemento panca lineare ed angolare H.85. Disponibile in tutte le finiture Ontario

Linear and corner bench element H.85 Available in all Ontario finishes.

**S07**



Sedia con seduta legno impagliata. Disponibile in tutte le finiture ONTARIO

Chair with straw seat. Available in all ONTARIO finishes.

**SGA03**



Sgabello con seduta legno impagliata. Disponibile in tutte le finiture ONTARIO

Stool with straw seat. Available in all ONTARIO finishes.





## FINITURA ROVERE GESSATO. LIMED OAK DECAPÉ FINISHES



Anta legno  
Wooden door

Anta vetro all'inglese  
English style glass door

Cassetto  
Drawer

Cestone legno  
Wooden Basket

Cestone legno con fughe verticali  
(solo h. 37,7 cm.)  
Basket with vertical lists  
(H.37,7 cm. only)

Cestone vetro all'inglese  
English style glass basket

## FINITURA FRASSINO LACCATO MAGNOLIA. MAGNOLIA LACQUERED COLOR ASH



Anta legno  
Wooden door

Anta vetro all'inglese  
English style glass door

Cassetto  
Drawer

Cestone legno  
Wooden Basket

Cestone legno con fughe verticali  
(solo h. 37,7 cm.)  
Basket with vertical lists  
(H.37,7 cm. only)

Cestone vetro all'inglese  
English style glass basket

## MANIGLIE DI SERIE. STANDARD HANDLE.

M81 interasse 96 mm. (standard su rovere)  
Distance between centres 96 mm. (standard on oak)



M81C interasse 96 mm. (standard su laccato)  
Distance between centres 96 mm. (standard on lacquered)



Maniglia a conchiglia finitura argento martellato  
Shell handle with hammered silver finish

Maniglia finitura argento martellato con inserto ceramico  
Handle with hammered silver finish and ceramic insert

## MANIGLIE E POMOLI OPTIONAL. OPTIONAL HANDLES AND KNOBS.

M81B interasse 96 mm. (optional)  
Distance between centres 96 mm. (optional)



M81D interasse 96 mm.  
Distance between centres 96 mm.



Maniglia a ponte argento martellato  
Bridge handle with hammered silver finish

Maniglia a ponte finitura argento.  
Silver finish bridge handle.

M81E interasse 96 mm. (optional)  
Distance between centres 96 mm. (optional)



P81E (optional)



Maniglia finitura cromo lucido  
Gloss chrome finish handle

Pomolo finitura cromo lucido  
Gloss chrome finish knob



## TIPOLOGIA PIANI DI LAVORO. WORKTOPS.

PIANI LAMINATO SP. 4, 6 CM.  
BORDO UNICOLOR  
LAMINATE WORKTOP,  
DEPTH 4 OR 6 CM. UNICOLOR TRIM



PIANI LAMINATO SP. 4 CM.  
RAGGIO 2 MM.  
LAMINATE WORKTOP 4 CM. DEPTH  
RADIUS 2 MM



PIANI LAMINATO SP. 6 CM. POSTFORMATO  
LAMINATE WORKTOP, DEPTH 6 CM. POSTFORMED

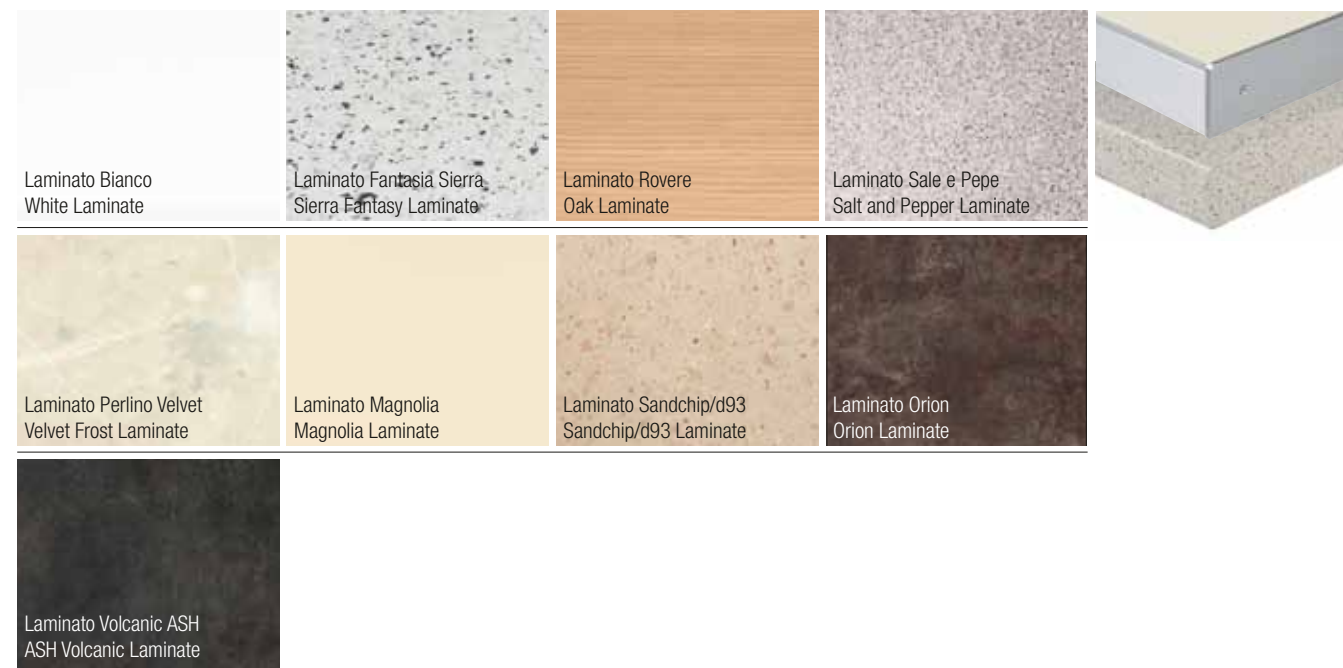

PIANI MURATURA SP. 4, 6 CM.  
MASONRY TOPS THICK. 4.6 CM.

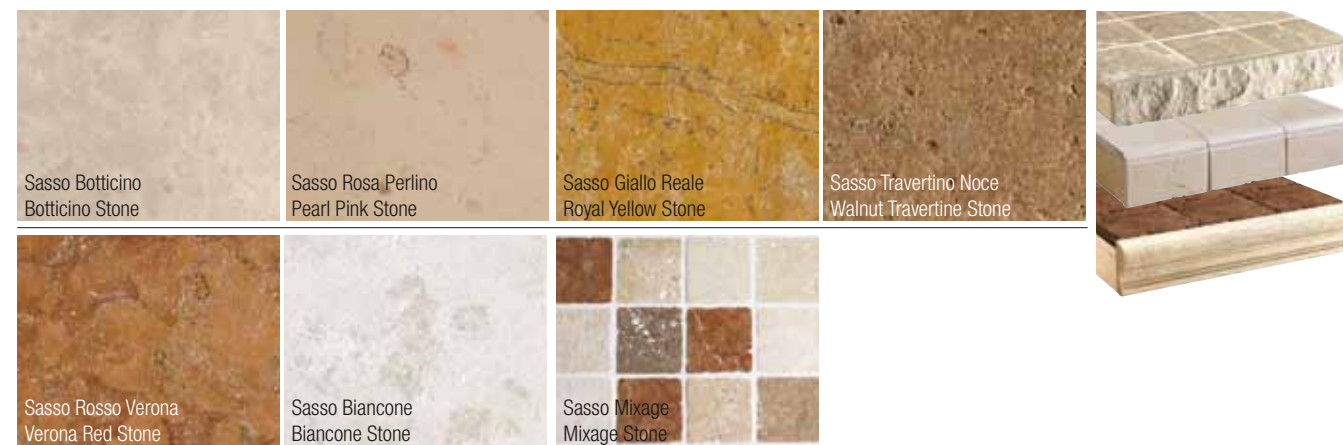

## TIPOLOGIA PIANI DI LAVORO. WORKTOPS.

PIANI DI LAVORO IN OKITE.  
OKITE WORKING SURFACES.

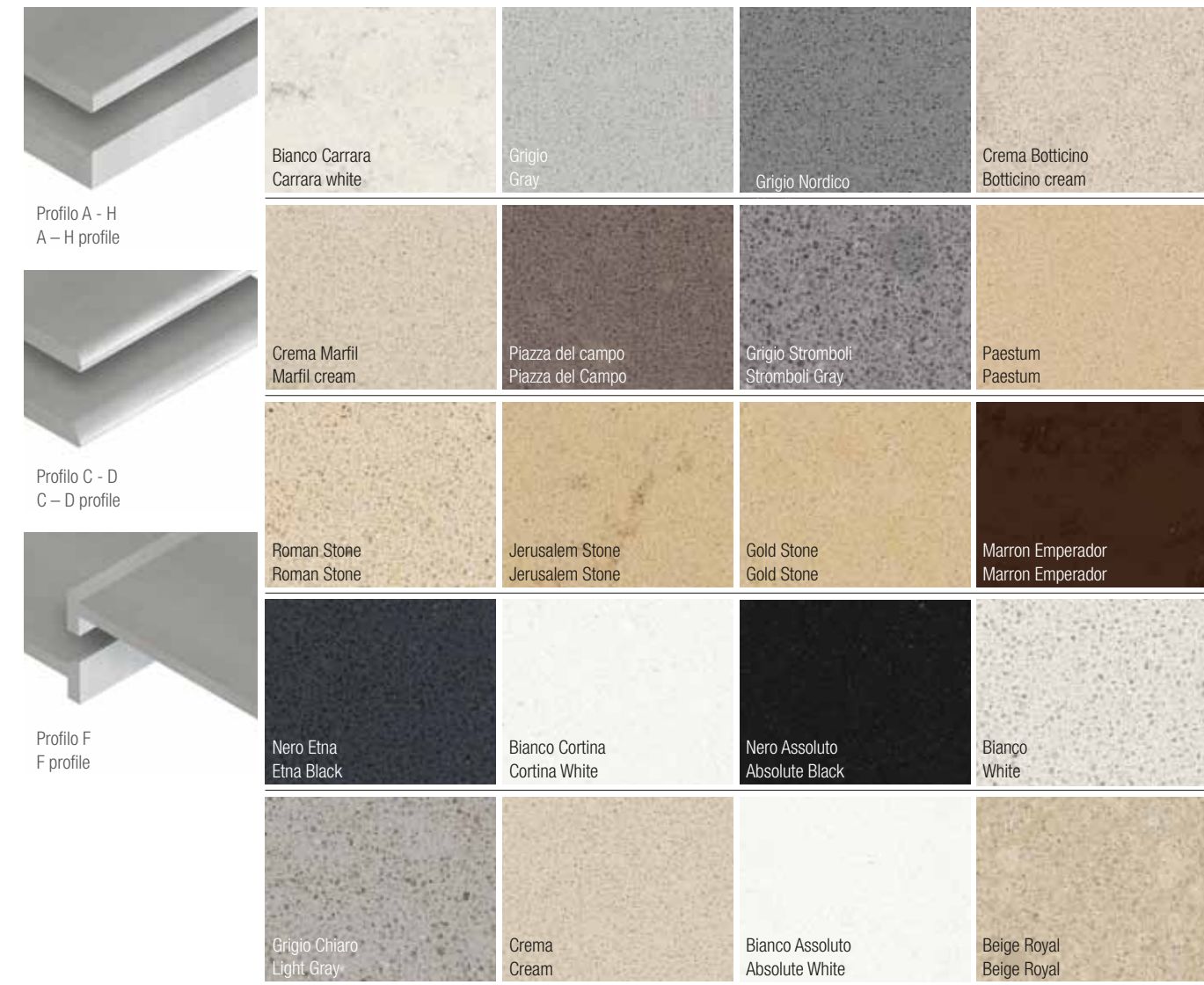

PIANI MARMO E GRANITO SP. 3 CM.  
MARBLE AND GRANITE WORKTOP, DEPTH 3 CM.

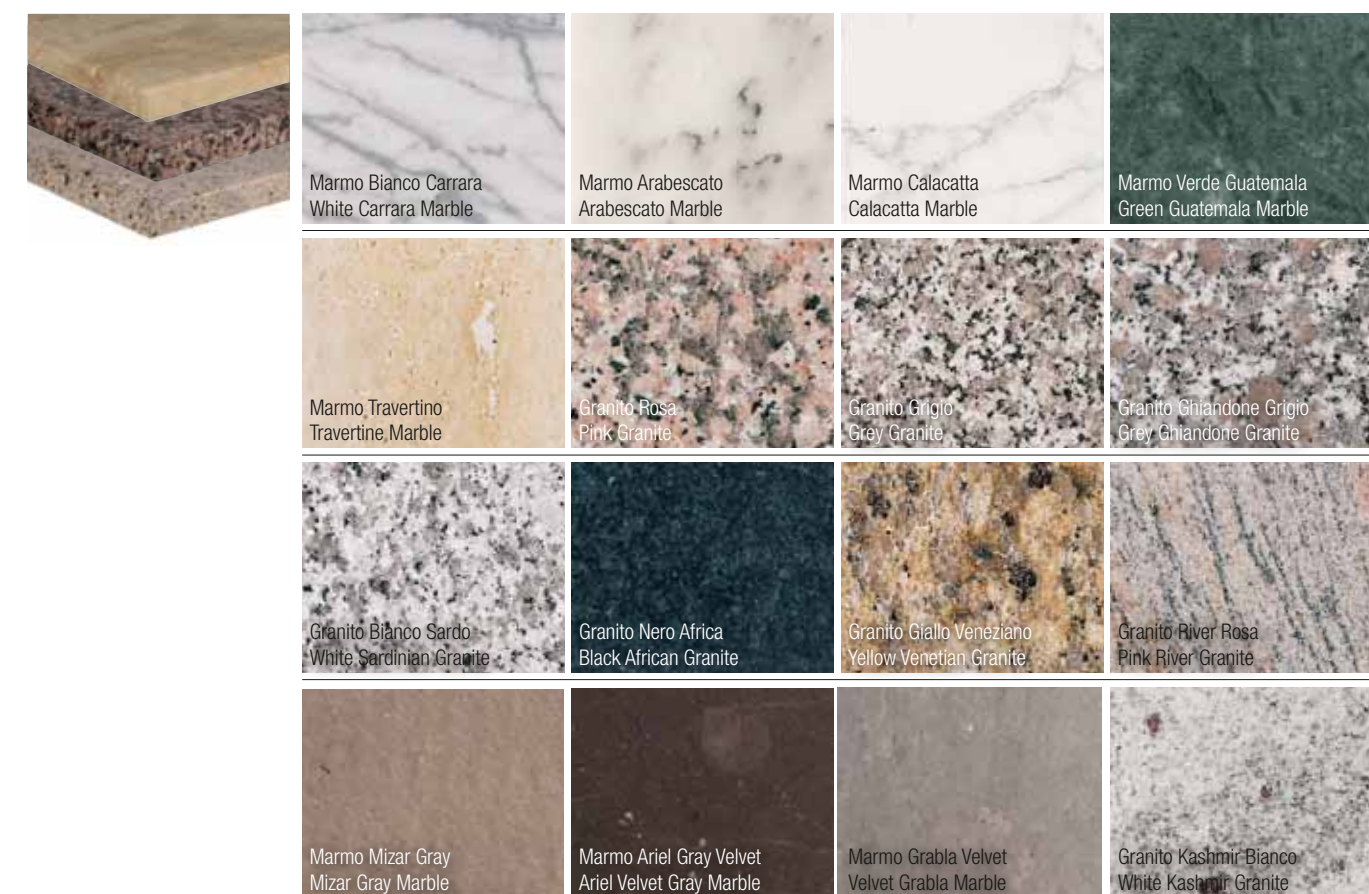





[www.stosa.it](http://www.stosa.it)

# ontario

design: Ettore Tinagli

agency: Kinetix multimedia

photo: LuceBLu

styling: Simona Fancelli

fotolito: Art and Pixel

print: Stampa 2000







## Stosa S.p.A.

STAB., SEDE AMM.VA E RECAPITO POSTALE:  
S.S. Cassia, Km. 149,5  
53040 Radicofani (SI) Italy

GPS:  
N 42° 53' 50,6"  
E 11° 45' 53,5"

INFO:  
tel. +39 0578 5711  
fax +39 0578 50088

INFO LINE:  
840 000 691

